

# Optimum Performance Innovative Design Maximum Capability



**LIQUIfit**<sup>TM</sup>

[www.liquifit.net](http://www.liquifit.net)

**legris**



7205 East Hampton Avenue | Mesa | Arizona | 85209-3301

Introducing

# LIQUIfit™

From the Trusted Inventor of the Push-to-Connect Fitting

With over 40 years of experience, Legris now presents a range of leak-free, push-to-connect fittings in a bio-based compact body.

## LIQUIfit Offers

- The most compact profile on the market
- EPDM patented sealing technology
- Full flow
- No pumping effect
- No need for locking clip or tube insert
- Optimum performance suitable for food and water contact
- 100% bio-based body



## Specifications

Applications: Water, beverages

For use with chemicals or other potentially aggressive liquids, contact Legris technical department.

Working pressure and temperature	1/4":	230 psi from 35°F to 100°F 150 psi at 150°F 60 psi at 200°F
	3/8":	190 psi from 35°F to 100°F 100 psi at 150°F 60 psi at 200°F
	1/2":	160 psi from 35°F to 100°F 100 psi at 150°F 60 psi at 200°F

Maximum circuit pressure depends equally on the type of tube used.

Maximum torque values for plastic threads NPT	1/8 and 1/4:	1.0 ft lbs / 1.5 Nm
	3/8 and 1/2:	2.2 ft lbs / 3.0 Nm

*Legris production process includes individual unit quality control and date coding, for all LIQUIfit push-to-connect fittings, in order to guarantee their quality and traceability.*

Liquifit fittings are in compliance with the following standards:



# LIQUIfit™

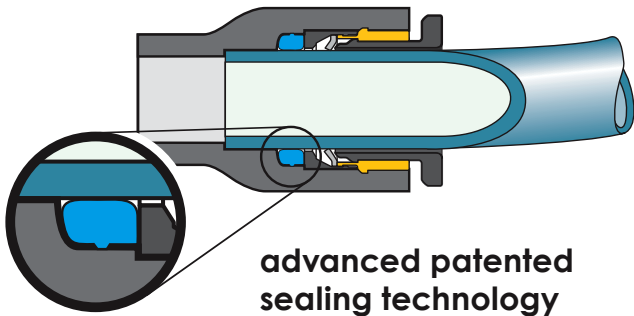

- **automatic sealing:** the D seal within the fitting provides a positive seal on the O.D. of the tube, in both static and dynamic positions, due to an optimized design of the fitting cavity.
- **internal hex:** allows ease of assembly in tight places.

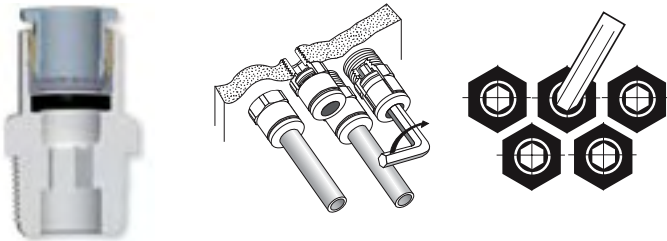

## innovative gripping technology

- the very low movement of Liquifit's gripping system avoids pumping effect
- more secure tube holding for tighter tube bends
- no tube insert or locking clip required at any working temperature (with Legris advanced tubing)



All Liquifit threaded fittings have a pre-applied PTFE thread sealant to save time during assembly.

## 100% renewable bio-based material

The body is manufactured of a unique bio-based high performance polyamide produced from renewable castor seeds, to expand the utilization of non-fossil based resource.



Castor Oil Plant

### Liquifit 1/4 fitting



### standard 1/4 fitting

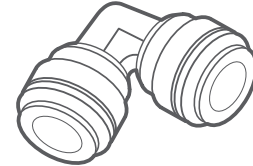

## most compact range on the market

- **convenient compact full flow profile:** as gripping and sealing within the fitting is achieved using the outside of the tube without deformation, there is no flow restriction. The smallest orifice inside the fitting is equal to or larger than the internal diameter of the tube.



## optimum wide-range material performance

Legris advanced PE tubing:



- 9 colors
- 3 sizes 1/4, 3/8, 1/2





## 6302 Union elbow

	Tube OD		Qty. per bag
	1/4	6302 56 00WP2	10
	3/8	6302 60 00WP2	10
	1/2	6302 62 00WP2	5



## 6306 Union connector

	Tube OD1	Tube OD2		Qty. per bag
	1/4		6306 56 00WP2	10
	1/4	3/8	6306 56 60WP2	10
	3/8		6306 60 00WP2	10
	3/8	1/2	6306 60 62WP2	5
	1/2		6306 62 00WP2	5



## 6304 Union tee

	Tube OD		Qty. per bag
	1/4	6304 56 00WP2	10
	3/8	6304 60 00WP2	10
	1/2	6304 62 00WP2	5

## 6316 Bulkhead union

	Tube OD		Qty. per bag
	1/4	6316 56 00WP2	10
	3/8	6316 60 00WP2	10
	1/2	6316 62 00WP2	5



## 6340 Two-way divider

	Tube OD		Qty. per bag
	1/4	6340 56 00WP2	10
	3/8	6340 60 00WP2	10
	1/2	6340 62 00WP2	5



## 6351 End stop

	Tube OD		Qty. per bag
	1/4	6351 56 00WP2	10
	3/8	6351 60 00WP2	10



## 6366 Reducer

	Tube OD	Stem		Qty. per bag
	1/4	5/16	6366 56 08WP2	10
	1/4	3/8	6366 56 60WP2	10
	3/8	1/2	6366 60 62WP2	5



## 6382 Plug-in elbow

	Tube OD	Stem		Qty. per bag
	1/4	1/4	6382 56 00WP2	10
	3/8	3/8	6382 60 00WP2	10
	1/2	1/2	6382 62 00WP2	5



## 6388 Plug-in tee

	Tube OD	Stem		Qty. per bag
	1/4	1/4	6388 56 00WP2	10
	3/8	3/8	6388 60 00WP2	10
	1/2	1/2	6388 62 00WP2	5



## 6322 Tube to hose stem

	Tube OD	Stem		Qty. per bag
	1/4	1/4	6322 56 56WP2	10
	3/8	1/4	6322 60 56WP2	10
	3/8	5/16	6322 60 08WP2	10
	3/8	3/8	6322 60 60WP2	10
	1/2	3/8	6322 62 60WP2	10



## 6326 Plug

	Tube OD		Qty. per bag
	1/4	6326 56 00WP2	10
	3/8	6326 60 00WP2	10
	1/2	6326 62 60WP2	5



## 6305 Male connector - NPTF thread

	Tube			Qty. per bag
	OD	Thread		
pre-applied thread sealant	1/4	1/8	6305 56 11WP2	10
	1/4	1/4	6305 56 14WP2	10
	3/8	1/4	6305 60 14WP2	10
	3/8	3/8	6305 60 18WP2	10
	1/2	3/8	6305 62 18WP2	5
	1/2	1/2	6305 62 22WP2	5



## 6308 Swivel branch tee - NPTF thread

	Tube			Qty. per bag
	OD	Thread		
pre-applied thread sealant	1/4	1/8	6308 56 11WP2	10
	1/4	1/4	6308 56 14WP2	10
	1/4	3/8	6308 56 18WP2	10
	3/8	1/4	6308 60 14WP2	10
	3/8	3/8	6308 60 18WP2	10
	1/2	3/8	6308 62 18WP2	4
	1/2	1/2	6308 62 22WP2	4



## 6315 Female connector - NPTF thread

	Tube			Qty. per bag
	OD	Thread		
	1/4	1/4	6315 56 14WP2	10
	3/8	3/8	6315 60 18WP2	10



## 6303 Swivel male run tee - NPTF thread

	Tube			Qty. per bag
	OD	Thread		
pre-applied thread sealant	1/4	1/8	6303 56 11WP2	10
	1/4	1/4	6303 56 14WP2	10
	1/4	3/8	6303 56 18WP2	10
	3/8	1/4	6303 60 14WP2	10
	3/8	3/8	6303 60 18WP2	10
	1/2	3/8	6303 62 18WP2	4
	1/2	1/2	6303 62 22WP2	4



## 6325 Faucet connector - UNS thread

	Tube			Qty. per bag
	OD	Thread		
	1/4	7/16-24UNS	6325 56 133WP2	10
	3/8	7/16-24UNS	6325 60 133WP2	10

## 6321 Stem adapter - NPTF thread

	Tube			Qty. per bag
	OD	Thread		
pre-applied thread sealant	1/4	1/8	6321 56 11WP2	10
	1/4	1/4	6321 56 14WP2	10
	1/4	3/8	6321 56 18WP2	10
	3/8	1/4	6321 60 14WP2	10
	3/8	3/8	6321 60 18WP2	10
	1/2	3/8	6321 62 18WP2	5
	1/2	1/2	6321 62 22WP2	5

## 6309 Swivel elbow - NPTF thread

	Tube			Qty. per bag
	OD	Thread		
pre-applied thread sealant	1/4	1/8	6309 56 11WP2	10
	1/4	1/4	6309 56 14WP2	10
	1/4	3/8	6309 56 18WP2	10
	3/8	1/4	6309 60 14WP2	10
	3/8	3/8	6309 60 18WP2	10
	1/2	3/8	6309 62 18WP2	5
	1/2	1/2	6309 62 22WP2	5

Liquifit comes in easy to hang packaging





### LIQUIfit™ range provides compact connections in all applications

- Suitable for a wide variety of uses in POU\* water purification systems

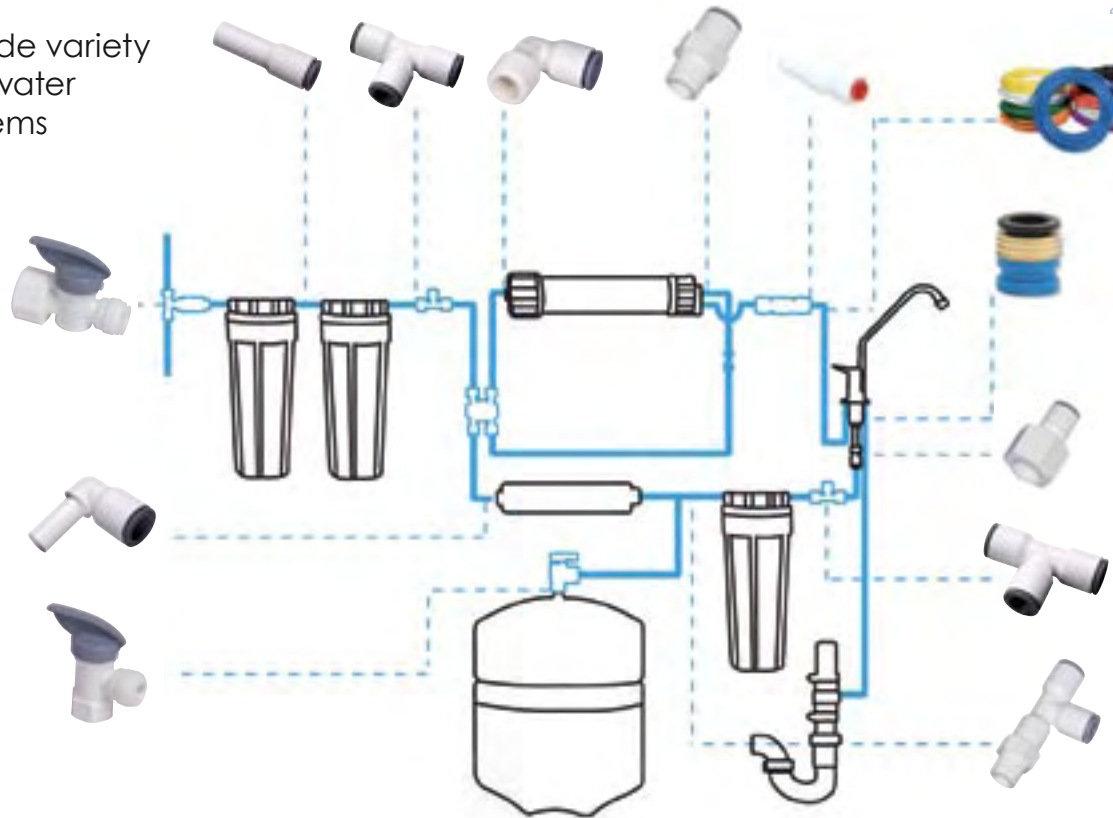

- Other typical areas of application for LIQUIfit™

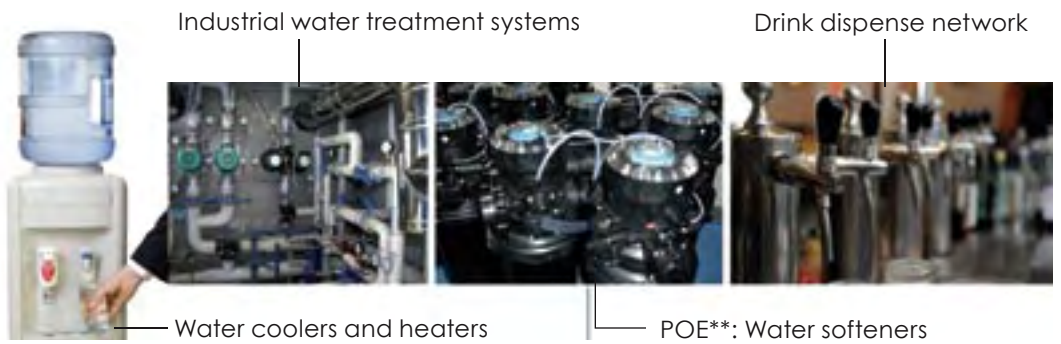

\* Point of Use  
\*\* Point of Entry

#### Contact info:

**Legris Incorporated**  
7205 East Hampton Avenue  
Mesa, Arizona 85209-3301

Tel: + 1 480-830-0216  
Fax: +1 800-839-7556  
liquifit-info@legris.com  
www.liquifit.net